

TULIKIVI FIREPLACES

© Tulikivi



Three billion years ago, the world was a ball of fire and smoke. The globe's crust began to cool, tectonic plates shifted restlessly and as they ground against each other, buckling at the edges, mountains rose. Miles beneath the Earth's surface, under tremendous pressure and heat, minerals began to crystallize – changing form, becoming stronger and creating something rare and wonderful -- soapstone. That is what happened in the heart of the Karelian mountains in Finland, in what is now the municipality of Juuka.

In time, the world quieted down, the sunlight brightened the land, and nature sprung to life. Humans populated Earth and tamed fire. Our ancestors, always adept at finding uses for the Earth's resources, discovered soapstone. It was heavier than other types of stone, yet it could be carved. Their tools, axes, and artifacts were admired as they shared their skills around the campfire. They revered this mystical stone believed to keep evil spirits at bay.

Humans began to put down roots and build houses. In the Nordic winter, the snow fell waist-high. The timber homes froze and split as the biting cold seeped between the logs. Soon our ancestors invented a new use for soapstone, providing warmth to their homes. Soapstone was ideal for fireplaces. They found that Mother Nature designed the perfect fireplace stone, durable with exceptional heat retention qualities. Soapstone helped the Nordic people endure the subzero winter and claimed its place in their lodges and cabins.

In the late 19th century, the Art Nouveau era was a Golden Age for soapstone. The wonderful gray stone became an architectural celebrity used in facades, floors, columns, stairwells, and other structures around the world. At the height of its popularity, it was transported by the ton to the royal courts of Europe. Many of these 19th century buildings look untouched by time, and their fireplaces are still in use.

As the modern world evolved, soapstone fell by the wayside. It has been rediscovered by a new generation – embracing their roots and respecting the warmth of fire and natural building materials, they craved something real.

Suomen Vuolukivi (now Tulikivi Corporation) had a vision in the 1980s and the company reopened the soapstone quarry in Nunnanlahti, a village in Juuka, Finland. They were soon joined by a team of engineers who were inspired by this vision for soapstone fireplaces. Together they developed a soapstone fireplace that heats today's homes efficiently and sets the mood and appearance for the most discerning customer – the Tulikivi fireplace was born. Each Tulikivi fireplace is made using real soapstone from eastern Finland. The secret behind soapstone's wonderful capacity to store fire energy is its high density, providing a clean-burning heat source that absorbs heat efficiently and radiates it slowly over a long time.

We Finns are a nation with our roots in the forest and fire close to our hearts. Mystical soapstone and the gentle warmth of a wood-burning fireplace have an enduring value that is once again welcomed into homes, both in the country and the cities. Soapstone is a natural, down-to-earth, graceful and beautiful home companion for warmth and decorative appeal.

When the wind howls, the rain whips down, and your soul craves warmth ... invite your family and friends to join you in the magic circle of the Tulikivi fireplace. Ask them to touch the classic gray surface ... feel its calming effect... strong and resilient with an earthy and friendly radiant warmth. There is still a need for such a stone and such a fireplace ... in this cold, cold world.





## Light the spark of life!

Fire warms stone .....	4
Fireplaces .....	8
Bakeovens .....	12
Lightweight fireplace .....	14
Interior Stone Tiles .....	15
Custom-made fireplaces .....	16
Remodel/Retrofit.....	23
Rock-solid facts .....	24
Technical information .....	28





## Fire warms stone. Therein lies Tulikivi's product idea.

Although soapstone is an ancient discovery, its popularity is not showing any signs of waning. It's no wonder then, that this mysterious stone is also a pleasure to work. This is what Tulikivi Corporation does, and we have three decades of experience behind us. We manufacture Tulikivi soapstone fireplaces. They are efficient at retaining heat, which is released slowly and evenly, allowing you to bask in the glow for an enjoyably long time. We have the most extensive range of fireplaces on the market, containing a wide selection of classic models, as well as many new, modern alternatives.

### THE WHOLE WORLD IS OUR HOME

We have grown from a small family business into the world's largest soapstone processing company. We are also the largest manufacturer of industrially produced heat-retaining fireplaces in the world. Over half of the products we produce are exported, primarily to Europe and North America. These days, we quarry soapstone in Juuka and Suomussalmi, which lie at the heart of Eastern Finland's hilly country. Our company employs 400+ stoneworkers. Product development is a continuous and fulltime process.





#### THE CUSTOMER ALWAYS COMES FIRST

There are already over a quarter of a million contented Tulikivi fireplace owners worldwide. Our customers are also the market's most satisfied according to independent studies.

The quality of the Tulikivi products and services, a key customer satisfaction factor, are second to none. We provide a five-year warranty on all of our fireplaces, and our company is the first fireplace manufacturer to use the European ISO 9001:2000 quality system. Tulikivi fireplaces and ovens are the only masonry heaters in North America tested and listed to UL / ULC standards.

#### STONE – A MATERIAL FOR THE WHOLE HOME

In addition to fireplaces, various interior decoration and architectural stones form part of the foundation of Tulikivi's business. Soapstone is a handsome and durable material for floors, walls, bathrooms and kitchens.

Tulikivi knows the tough, resilient nature of natural stone stands up to time and wear and always retains its appeal. Isn't there a place for such a material in the interior decoration of your home?

#### NOW IT'S TIME TO TAKE A READING BREAK

Turn off your mobile phone, switch off your monitor, and spend some quiet moments under the soft glow of your reading lamp with a heart-warming companion: our catalogue. Let it open the doors into the magical world of Tulikivi fireplaces.

**If our catalogue sparks your curiosity,  
visit us at [www.tulikivi.com](http://www.tulikivi.com).**



## Environmentally Sound Warmth from Wood

Forests are the lungs of our planet. This is due to the fact that every tree absorbs carbon dioxide from the air and transforms it into carbon which is then stored as one component of wood. Therefore wood, when burned, releases as much carbon dioxide as the tree has absorbed during its lifetime. That is why wood biomass – as opposed to fossil fuels like coal or oil – is called “carbon dioxide neutral”, since the release and absorption of carbon dioxide constitute a circle.

The US Environmental Protection Agency stated that the greenhouse effect could be reduced by using more fuels made from biomass.

*The natural carbon dioxide circle – Trees absorb carbon dioxide from the air. This gas goes back into the air when the tree rots or when the wood is burned in a Tulikivi fireplace. The circle starts again.*

## Clean air – inside and outside

A healthy heating system cannot be judged by its BTU output, but by the quality of heat released by it. A Tulikivi fireplace releases soft, constant radiant heat up to 24 hours. This heats up the walls of the building, thus preventing the generation of humidity (the main cause of mold) and therefore creating a fresh and healthy indoor climate. Less movement of air and healthy walls are the be-all and end-all of a clean and healthy indoor climate. Radiant heat greatly differs from the hard convection heat of traditional stoves.

A Tulikivi fireplace burns wood fast and completely (with an efficiency of more than 80%) and therefore uses almost all the existing energy. The emissions amount to only a small percentage of the world’s strictest allowances, which leads to a considerable reduction of carbon dioxide. A small amount of wood is enough to heat your space comfortably, making it a healthy gathering point for the entire family.

*In Finland Tulikivi is entitled to use the logo of the Asthma and Allergy Association for its soapstone fireplaces with a Tulikivi Whirlbox.*

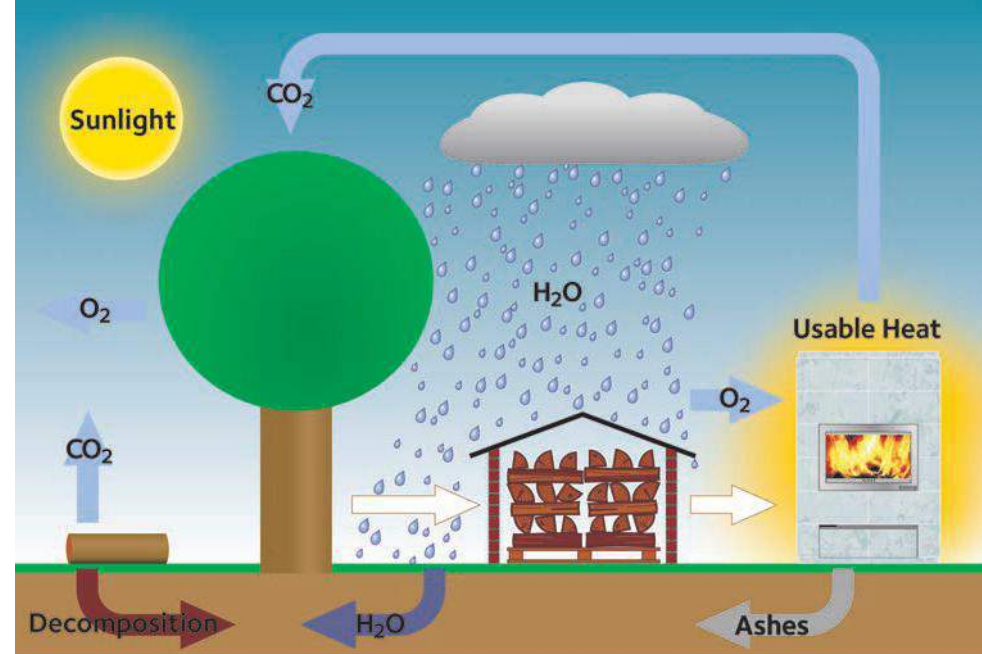

# Tulikivi Whirlbox

Soapstone is a dense, heat-resistant and solid material. Soapstone also has better heat retaining and thermal conductivity properties than other stones.

Wood is burned completely and the heat is stored in the soapstone mass. Tulikivis maximize the heat output of wood and are easy to use. A short 1- to 3-hour burn cycle per day will contribute a significant amount of heat to your home.

Like the energy from the sun, Tulikivi soapstone fireplaces and ovens produce gentle radiant heat. It is the healthiest form of heat and does not parch the air like metal stoves and hot air systems.

## THERMAL MASS

The thermal storage capabilities of our units allow you to continue heating while you are asleep or away, without a fire burning.

The Whirlbox is a new invention patented by Tulikivi. It lengthens the time combustion gases remain in the fire chamber allowing combustion to be not only efficient, but also exceptionally clean. Emissions from the fireplace remain at a fraction of the worlds strictest norms.

Relatively low surface temperatures make Tulikivis safe and enjoyable to touch.

Tulikivi fireplaces have ash boxes with lids, making ash removal convenient and clean – ash won't blow everywhere.

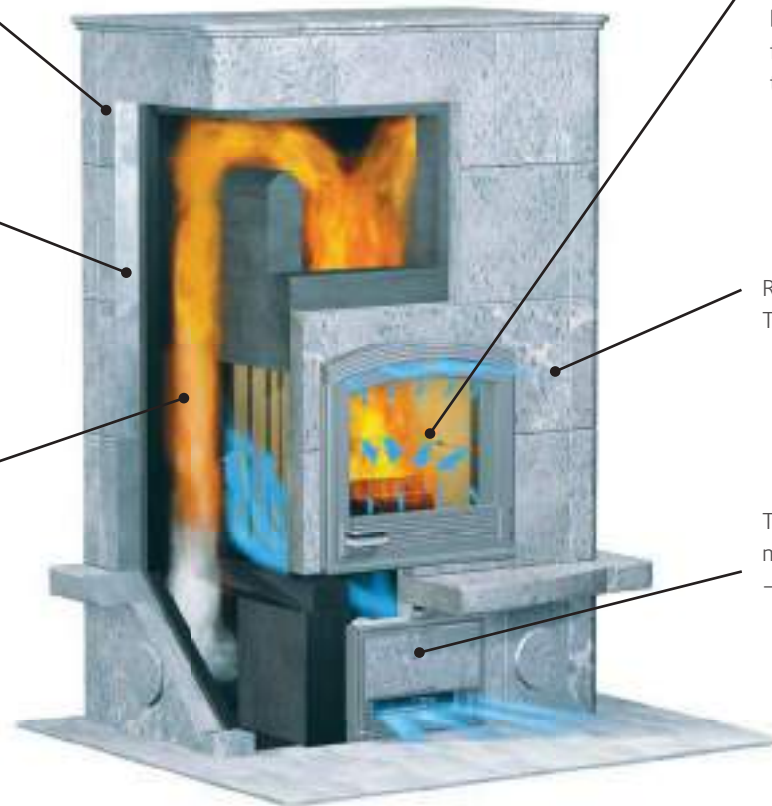

## ONE-OF-A-KIND

Modern production technology, skilled stoneworkers who take pride in their work, and dozens of years of experience, produce a one-of-a-kind fireplace for your home. All Tulikivis come with a five-year warranty.

## UL LISTED

Tulikivi ovens and fireplaces are the only masonry stoves in North America tested and listed to UL / ULC standards.

## INSTALLATION

Tulikivi fireplaces are delivered to your home and installation is carried out by an authorized Tulikivi installer ready for use: all you need to do is light the match.





TTU2700/2 See Through

### Tulikivi fireplaces

The Tulikivi fireplace family includes models with modern lines and many traditional, timeless classics. Whether you like to bask in the heat or just love to watch the flames, you'll find more than enough alternatives. Whatever your taste in interior decor and no matter what type of house you live in, it will be easy to find your favorite from our lasting designs.



TTU2700/4  
Single sided



TTU2700/51  
See Through, with bakeoven





TU2200 with top vent



TU2200/4



TU2200/5



TU2200/1



TU2500L



TU1237/51



TU1450/1



KTU1410/1  
Corner fireplace



TU1237 Custom model with top vent



## Timeless Nature Meets Modern Marvel ...

Tulikivi combines timeless beauty with durable natural soapstone and clean geometric lines to form the perfect union in their contemporary fireplaces. With enlarged glass doors, easily added modern benches and shelf solutions, your fireplace can be customized to fit your specific needs.



VALKIA + Storage Bench



PAHTA/F



SILO/C



VALKIA T



LLU1250

### Warm your appetite and your home ...

Whether you are a gourmet chef or a casual foodie, a Tulikivi bakeoven makes a wonderful companion. Please the appetites of family and friends with delectable pies and pizzas, roasts, casseroles and fresh baked bread – prepared just right, because Tulikivi's unique structure warms the oven evenly from top to bottom.

A Tulikivi bakeoven is more than just an oven; it also heats the room and adds a peaceful ambiance. You can burn wood separately in the fireplace or in the bakeoven and add style as well as function.

Make a statement between the most lived in areas of the home, with the Tulikivi fireplace open to the living room and the bakeoven open into the kitchen ... bring the warmth full circle.



KTLU2050/1  
Corner fireplace/bakeoven



TLU2137/13





TLU2000/91



TLU2000/92



TLU2480, from the fireplace side



TLU2480, from the bakeoven side



TLU2450/1

## Tulikivi Lightweight Fireplace - Hetta

Not all home's require a heat retaining fireplace. Many families want a fireplace primarily for those cozy evenings around the fire and as an extra source of heat.

The heart of Tulikivi's lightweight fireplace is a clean burning firebox. The steel structure of the firebox ensures rapid heat transfer into the room from the very first load. The fireplace exterior is soapstone, which slowly and pleasantly radiates retained heat into the room. Thanks to combustion air control, the flames will crackle for a long time, even when you use less wood.

Tulikivi's Hetta can even be installed on a combustible floor. Contact your Tulikivi representative for advice on your homes specific requirements.

The Hetta is not recommended for use as a primary source of heat. Rather, it is best used for setting the mood and as a secondary heat source, such as in houses with in-floor heating. This makes the fireplace suitable for many room configurations.





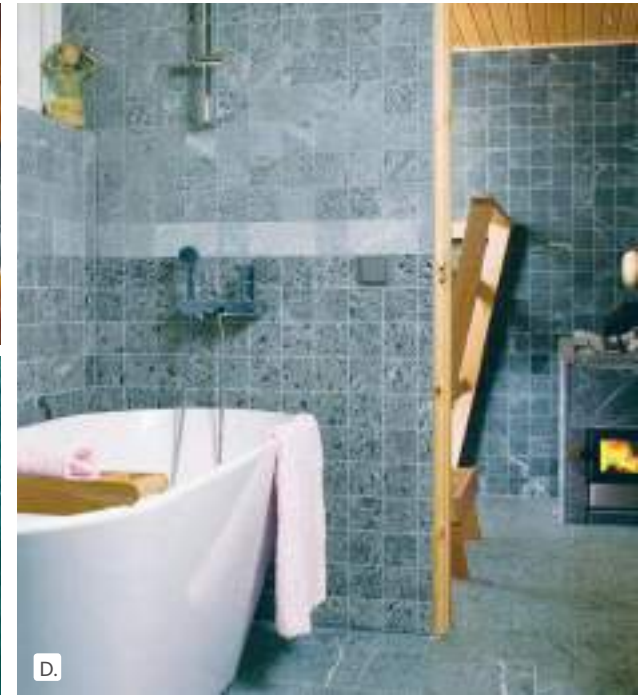

## Soapstone Tiles and Flooring.

No matter what style you choose, soapstone tile is a beautiful complement to any room. Soapstone has been used in homes for hundreds of years for its natural beauty and durability. Naturally resilient, soapstone will not burn, is stain resistant, and requires little maintenance.

As a flooring, soapstone is noiseless and soft to the touch. It is the perfect choice when used in a kitchen or bathroom where moisture may collect on the surface, because soapstone is water repellent and it is not slippery when wet.

Soapstone can be lathed, cut or polished. Its surface can be shaped, routed, cut, sandblasted or milled either by machine or with hand tools. This offers the interior designer, craftsman and architect an unlimited variety of creative options for personalizing and customizing flooring and tile facades.

For more information on any Tulikivi soapstone product, contact one of our handpicked and knowledgeable North American distributors. North American distributors are listed on the web at [www.tulikivi.com](http://www.tulikivi.com).

**A.&D.** Soapstone tile from Tulikivi makes the perfect bathroom material.

**B.&C.** Hearth extension and stairs made of Tulikivi Classic soapstone tiles.

## Soapstone tiles



TK-226, Tulikivi Classic  
( $\frac{3}{8}$ " x 12" x 12")



TK-280, Tulikivi Classic  
( $\frac{3}{8}$ " x 12" x 12")



TK-281, Tulikivi Blue  
( $\frac{3}{8}$ " x 12" x 12")



TK-282, Tulikivi Sky  
( $\frac{3}{8}$ " x 12" x 12")

## Tulikivi custom-made fireplaces

Soapstone can be fashioned into many forms. If you can't find just the model for you in this catalogue, don't worry. Tulikivi offers a custom design service to accommodate your unique ideas.

### ARCHITECTS LOVE US TOO

Our excellent fireplaces fit into any house and interior design. Our custom design service further expands the possibilities of designing a suitable fireplace for every space. Architects especially love our products.

*"I find that Tulikivi masonry heaters, with their high efficiency, their built for a lifetime quality, and their gentle heat, are the perfect complement to my timber framed homes. For the last 20 years, Tulikivi's have been dependably heating my own home and office."*

Jack A. Sobon, Architect  
Windsor, Massachusetts

*"Working with the Tulikivi products is a joy. Customization is limited only by the buyer's imagination. There always seems to be a standard model of the right size, proportion and function in which to add details or textures to suit the customer's taste. In the rare case where the right standard unit doesn't exist, Tulikivi's modular design allows infinite possibilities in creating a totally new unit. The modification doesn't affect the function. Regardless of the finishes a Tulikivi always warms your home."*

Rann Haight, Architect (designer of the unit on the right)

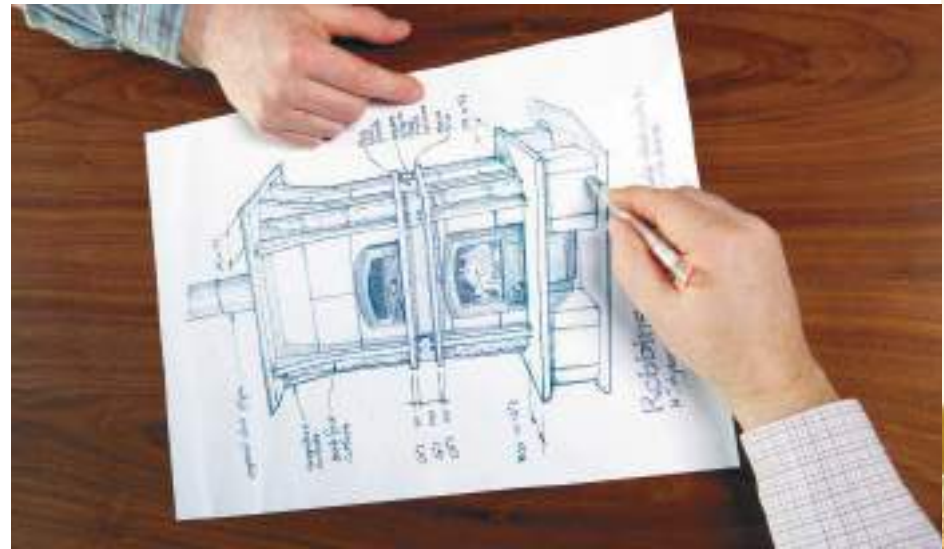







TTU2700/5 Custom



KIPIPELTO (front)



KIPIPELTO (bakeoven side)





KLTU 2235 Custom



KLTU 2235 Custom, bakeoven side





YKOL



TU2337 Special



Fiorina Special



BOULDER FRANCE (BACK)



BOULDER FRANCE (FRONT)



BOULDER USA







Highlands See-through



TU1000 custom



TU2200 custom





### Retrofitting a Tulikivi

There is often a perception that retrofitting a Tulikivi will be a difficult process when in actuality Tulikivi's UL listings and design flexibility make the process relatively simple. The combination of Tulikivi's clearance listings and venting options allow for more elegant design options than afforded with a typical woodstove or fireplace insert.

#### EXISTING CHIMNEY SYSTEMS

Tulikivi's UL listing allows for many types of venting options. These include flue location; the back, the side or the top, as well as flue types, such as masonry and Class-A stainless steel. In most cases, retrofitting in place of an existing fireplace will only require the existing chimney be fitted with a stainless steel liner.

#### EXISTING HEARTH'S

Tulikivi's can be installed on existing raised hearths with soapstone extensions for added support and hearth requirements.

For installations on an existing floor level hearth, use Tulikivi's approved floor heat shield. The pictures above show this type of installation.

#### SPACE REQUIREMENTS & COMFORT ZONES

It is a common misconception that a Tulikivi will take up much more space than a typical woodstove and that because of its large physical mass it will overheat the living space. In fact, Tulikivi's UL approved heat shield reduces clearances to 3-inches from combustibles. Safe temperatures on the soapstone's surface make it possible to sit very close or even against a Tulikivi fireplace. The large thermal mass provides for a constant and even temperature for many hours after the fire is out.

#### NEUTRAL COLOR

Tulikivi's neutral grey color blends well with any interior décor and color scheme.

# Rock-solid facts

The world of Tulikivi includes a number of technical subtleties and offers a lot of solid service. Find out more on the following pages.

## FOR BETTER COMBUSTION

The heart of the fireplace is the fire chamber, affecting the whole functioning of the fireplace.

The whirlbox is an invention patented by Tulikivi. It lengthens the time combustion gases remain in the combustion chamber. Thus combustion is more effective and also exceptionally clean. The emissions from the fireplace amount to only a small percentage of the emissions permitted by the world's strictest emission norms.

## APPROVED BY THE AUTHORITIES

Tulikivi fireplaces have also passed the strictest screenings carried out by testers around the world and our fireplaces have outperformed many others.

Tulikivi was the first fireplace producer to receive the ISO 9001 quality management certificate.

Tulikivi fireplaces have passed the industry's most demanding safety tests and comply with the world's strictest emission norms (the Rosenheim IBR certificate among others).

On top of this, we are actively involved in Finnish and international research and development. Planning for the future is progressing in leaps and bounds at Tulikivi.

## THE ENVIRONMENTALLY-FRIENDLY WAY TO REDUCE YOUR HEATING COSTS!

The future of fossil fuels looks grim: supplies are getting scarce and prices are continuously increasing. The burning of fossil fuels also brings with it insurmountable environmental problems and contributes to the global greenhouse effect.

## A DEFENSE OF WOOD HEATING

Wood heating is a traditional, natural and low-cost form of energy. When burnt, wood releases the same amount of carbon dioxide into nature's carbon cycle as it does when it decays in the forest. The price of wood is also competitive compared to that of electricity and oil. (see upper right chart). Tulikivi fireplaces also use very little wood. Many people use a fireplace as a source of extra heat – a subtle way to cut home heating costs.

In order for wood to burn properly, it needs to be sufficiently dry (a moisture content of 15–20%). A suitable log length is about 10 – 16 inches (depending on model). Your wood storage should be protected from moisture and positioned to have ample airflow surrounding it.

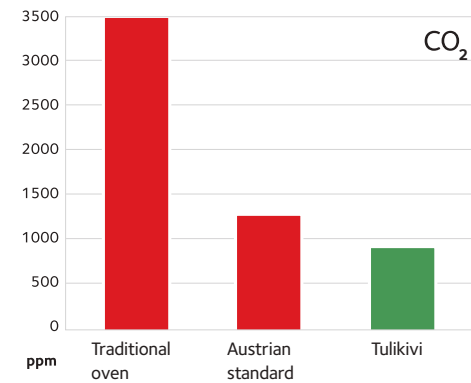
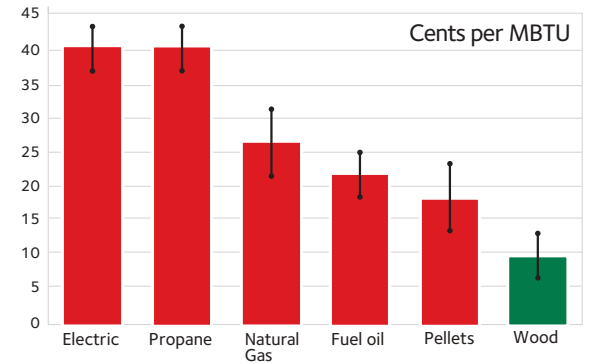

The diagram shows the amount of carbon monoxide given off by a traditional fireplace and Tulikivi whirl chamber. The world's strictest norms for emissions – those of Austria – have been used as a baseline.



For heat-retaining fireplaces, Tulikivi is the quality leader. Our products have been tested and approved all over the world. We continuously engage in close cooperation with international research centers.



**ROOM TEMPERATURES WITH DIFFERENT TYPES OF FIREPLACES.**  
 How many times would you like to heat your fireplace per day? The chart above shows a comparison between a traditional fireplace and a Tulikivi soapstone fireplace. The pleasant radiant heat of a Tulikivi heat-retaining fireplace lasts a whole day.

**WHATEVER YOUR HEATING NEEDS, WE HAVE A FIREPLACE TO FIT THEM**

A soapstone fireplace with a smaller mass retains less heat and cools more quickly than a larger one. A larger fireplace stores more energy, which is released slowly into the room, keeping it warm for an extended period. However, a Tulikivi fireplace always soundly beats a wood stove, for example, which only gives off heat for a relatively short period, with many peaks and lows during every heating cycle. As shown in the drawing on the right, this will save you work and wood.

The following diagrams below show how heat is released from Tulikivi fireplaces when heated according to owners manual.

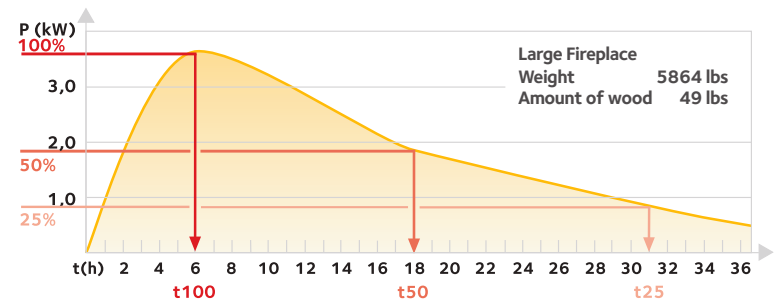
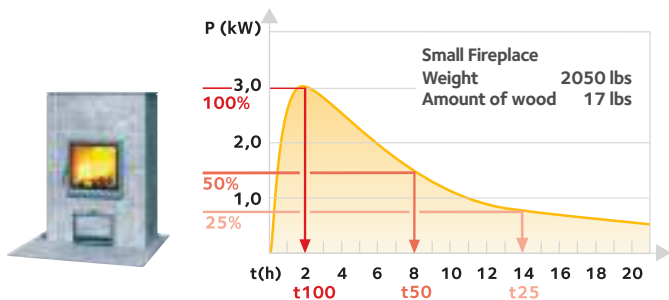
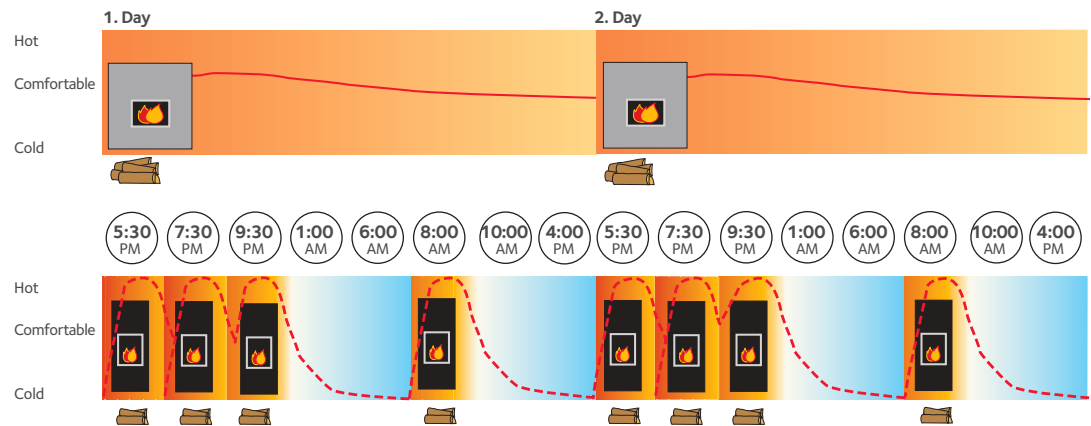

A small Tulikivi fireplace achieves its peak instantaneous heat release (3 kW) approx. 2 hours after heating is started. This fireplace continues to release 50% of its heat output 8 hours after heating is started and 25% of its heat output 14 hours after heating is started. A large Tulikivi fireplace reaches its peak instantaneous heat release (3.6 kW) approx. 6 hours after heating is started. It then releases 50% of its instantaneous heat output 18 hours after heating is started and 25% of its instantaneous heat output 31 hours after heating is started.

# The features of a Tulikivi fireplace

There is enough contemporary design, technology and engineering skill to be found in Tulikivi fireplaces to provide material for hundreds of pages.

We would, however, like to save you time by gathering together all the finest points of Tulikivi's fireplaces in this spread. If you are considering buying a new fireplace, it's worthwhile to read these lines carefully.

## A TULIKIVI HEAT-RETAINING FIREPLACE IS A VERITABLE POWERHOUSE OF HEAT

Soapstone seems born for the fireplace, and Tulikivi is a magnificent soapstone fireplace.

The magic of a heat-retaining Tulikivi fireplace is based on the excellent thermal conductivity and the heat retaining properties of soapstone. Together with its high specific density, these properties ensure exceptional heating efficiency, and heat will be radiated for a long period of time.

Firewood burns quickly and efficiently in the firebox and the solid mass of the fireplace rapidly stores the heat. A couple of loads of wood are sufficient to heat any room, and heat will be radiated up to 24 hours or more.

A Tulikivi fireplace does not waste heat or wood like a normal stove or open fireplace, which have to be continually fed to keep the fire burning.

## THE HEAT FROM A TULIKIVI FIREPLACE IS SOFT AND GENTLE, IT DOES NOT BURN

Radiant heat generated by soapstone is pleasant and also efficient. A Tulikivi fireplace emits heat evenly over the whole room, remaining pleasantly warm for a long time, even after the fire has gone out.

A Tulikivi fireplace will not burn the air leaving it dry and stuffy; the air will remain fresh.

This is how radiant heat differs favorably from the harsh convection heat of a traditional stove.

Because a Tulikivi fireplace is not short-tempered and fiery, you can even lean against the side of the fireplace and rest your hand against the stone. A wood burning Tulikivi fireplace brings out the nostalgic memories in many people - it's hard to put the meaning into words.

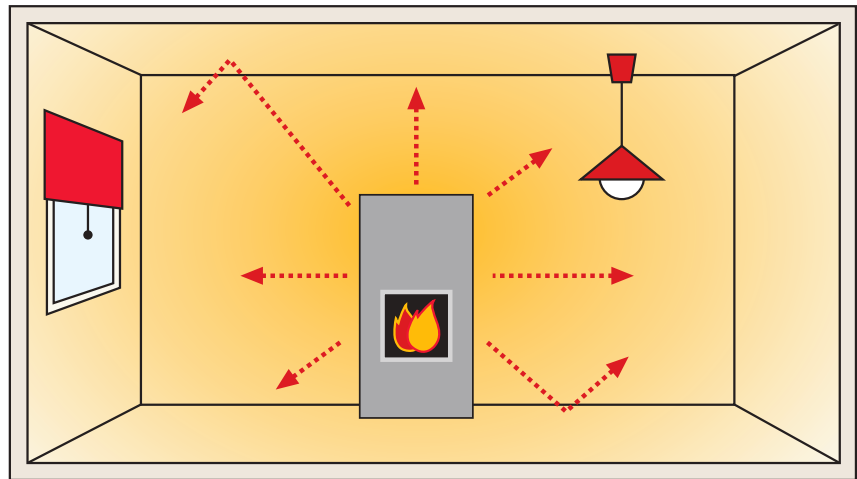

*The soft radiant heat of a Tulikivi fireplace spreads evenly in the whole room and gently warms people and objects. Because you are heating with radiant heat, the room doesn't reach extreme temperatures as it does with a wood stove, instead the air remains fresh and easy to breathe.*

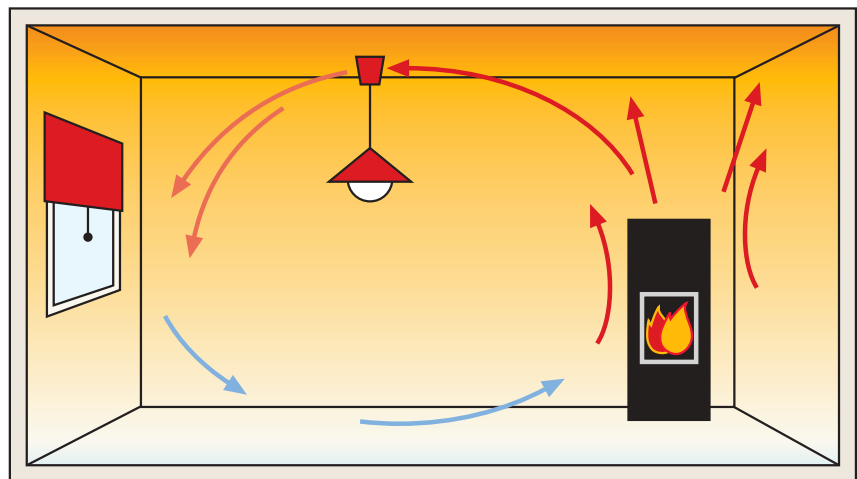

*The convection heat of a traditional wood stove rises towards the ceiling and is concentrated around the stove. The heat is not retained in anything, but escapes through the chimney.*





#### ALL YOU HAVE TO DO IS LIGHT THE MATCH

If you are thinking of buying a Tulikivi fireplace, visit your dealer to view our models in the showroom.

You can also invite a Tulikivi dealer to call at your home. Your dealer will listen to your wishes and guide you towards the right model, as well as find a suitable location for your fireplace. Your dealer is familiar with all of Tulikivi's products, including our interior decoration stone solutions. All you need to do is ask.

Our end-to-end service is concluded with the installation of your fireplace by a trained Tulikivi installer. You can also ask your installer for advice on other work, such as removal of your old fireplace, repairs to your flue or fire wall, hearth and floor tiling – whatever it is that you need.

Our installers work to ensure that your new fireplace works like a charm, and will also give you all the tips and finer points you need to know to get the best out of your fireplace. Our installers will leave the installation spotless and hand you the matches: all you need to do is light one. And that's where it starts – a long, warm and trusting relationship with your Tulikivi fireplace.

#### A WARM-UP KIT FOR EVERY NEW FIREPLACE OWNER

As a thank-you for purchasing your Tulikivi fireplace, you will receive a warm-up kit. Inside, you will find information on how to heat and care for your fireplace, detailed operating instructions (on DVD) and cleaners.

Also find us on facebook







<http://www.facebook.com/Tulikivi>

Or on YouTube:



<http://www.youtube.com/user/TulikiviOyj>

MODELS			DIMENSIONS				HEATING TECHNOLOGY			FLUE CONNECTION			
	Page	Group	Weight (lbs)	External dimensions width/ depth/ height (")	Dimensions of the fireplace firebox width/ depth (")	Dimensions of the bakeoven firebox width/ depth (")	Stored energy  (BTU)	Room area (guidance value)  Sq.Feet *	Electrical elements  	Recommended flue (") 	Height of con- nection pipe  (")	Bottom flue connection  	Top flue connection  
<b>FIREPLACES</b>													
TTU2700/2	8	1	9612	63 <sup>3</sup> / <sub>4</sub> / 53 <sup>1</sup> / <sub>8</sub> / 86 <sup>1</sup> / <sub>2</sub>	15 <sup>3</sup> / <sub>4</sub> / 24 <sup>3</sup> / <sub>4</sub>	-	327540	1600	○	8"	-	○	●
TTU2700/51	8	1	8421	63 <sup>3</sup> / <sub>4</sub> / 53 <sup>1</sup> / <sub>8</sub> / 86 <sup>1</sup> / <sub>2</sub>	15 <sup>3</sup> / <sub>4</sub> / 24 <sup>3</sup> / <sub>4</sub>	16 <sup>1</sup> / <sub>2</sub> / 17 <sup>1</sup> / <sub>8</sub>	327540	1600	○	8"	-	○	●
TTU2700/4	8	1	5688	40 <sup>1</sup> / <sub>8</sub> / 29 <sup>1</sup> / <sub>2</sub> / 72	15 <sup>3</sup> / <sub>4</sub> / 14 <sup>3</sup> / <sub>8</sub>	-	295904	1400	○	7" or 8"	-	○	●
TU2200	9	1	4056	40 <sup>1</sup> / <sub>8</sub> / 23 <sup>5</sup> / <sub>8</sub> / 60 <sup>1</sup> / <sub>4</sub>	15 <sup>3</sup> / <sub>4</sub> / 14 <sup>3</sup> / <sub>8</sub>	-	225601	1200	○	7" or 8"	11 <sup>3</sup> / <sub>4</sub>	●	○
TU2200/1	9	1	4806	42 <sup>1</sup> / <sub>2</sub> / 23 <sup>5</sup> / <sub>8</sub> / 65	15 <sup>3</sup> / <sub>4</sub> / 14 <sup>3</sup> / <sub>8</sub>	-	275735	1300	○	7" or 8"	11 <sup>3</sup> / <sub>4</sub>	●	○
TU2200/4	9	1	4123	40 <sup>1</sup> / <sub>8</sub> / 23 <sup>5</sup> / <sub>8</sub> / 62 <sup>5</sup> / <sub>8</sub>	15 <sup>3</sup> / <sub>4</sub> / 14 <sup>3</sup> / <sub>8</sub>	-	238135	1200	○	7" or 8"	11 <sup>3</sup> / <sub>4</sub>	●	○
TU2200/5	9	1	4144	40 <sup>1</sup> / <sub>8</sub> / 23 <sup>5</sup> / <sub>8</sub> / 65	15 <sup>3</sup> / <sub>4</sub> / 14 <sup>3</sup> / <sub>8</sub>	-	238135	1200	○	7" or 8"	11 <sup>3</sup> / <sub>4</sub>	●	○
TU2500L	9	1	5247	42 <sup>1</sup> / <sub>2</sub> / 23 <sup>5</sup> / <sub>8</sub> / 76 <sup>3</sup> / <sub>4</sub>	15 <sup>3</sup> / <sub>4</sub> / 14 <sup>3</sup> / <sub>8</sub>	-	300802	1400	○	7" or 8"	11 <sup>3</sup> / <sub>4</sub>	●	○
KTU1410/1	10	1	3042	40 <sup>3</sup> / <sub>4</sub> / 29 / 65	12 <sup>1</sup> / <sub>4</sub> / 9 <sup>5</sup> / <sub>8</sub>	-	165383	1000	○	6" or 7"	11 <sup>3</sup> / <sub>4</sub>	●	○
TU1237/51	10	1	3196	35 <sup>5</sup> / <sub>8</sub> / 23 / 65	22 <sup>1</sup> / <sub>2</sub> / 12 <sup>1</sup> / <sub>4</sub>	-	157316	1000	○	7" or 8"	11 <sup>3</sup> / <sub>4</sub>	●	○
TU1450/1	10	1	2976	35 <sup>1</sup> / <sub>2</sub> / 18 <sup>7</sup> / <sub>8</sub> / 62 <sup>5</sup> / <sub>8</sub>	12 <sup>1</sup> / <sub>4</sub> / 9 <sup>5</sup> / <sub>8</sub>	-	175468	1000	○	6" or 7"	11 <sup>3</sup> / <sub>4</sub>	●	○
VALKIA	11	2	3350	42 <sup>1</sup> / <sub>2</sub> / 19 <sup>5</sup> / <sub>8</sub> / 60 <sup>1</sup> / <sub>4</sub>	14 <sup>1</sup> / <sub>8</sub> , 20 <sup>1</sup> / <sub>2</sub> / 10 <sup>5</sup> / <sub>8</sub>	-	181518	1000	○	6" or 7"	13 <sup>5</sup> / <sub>8</sub>	●	○
Storage Bench	11		617	19 <sup>5</sup> / <sub>8</sub> / 41 <sup>5</sup> / <sub>8</sub> / 17 <sup>5</sup> / <sub>8</sub>									
PAHTA/F	11	2	4056	39 / 22 <sup>1</sup> / <sub>2</sub> / 69 <sup>5</sup> / <sub>8</sub>	14 <sup>1</sup> / <sub>8</sub> / 10 <sup>5</sup> / <sub>8</sub>	-	213068	1000	○	6" or 7"	13 <sup>5</sup> / <sub>8</sub>	●	○
SILO/C	11	2	2755	35 <sup>5</sup> / <sub>8</sub> / 19 <sup>1</sup> / <sub>4</sub> / 60 <sup>1</sup> / <sub>4</sub>	14 <sup>1</sup> / <sub>8</sub> / 10 <sup>5</sup> / <sub>8</sub>	-	146943	900	○	6" or 7"	13 <sup>5</sup> / <sub>8</sub>	●	○
<b>FIREPLACE/BAKEOVENS</b>													
TLU2450/1	13	1	6261	42 <sup>1</sup> / <sub>2</sub> / 35 <sup>3</sup> / <sub>8</sub> / 66 <sup>1</sup> / <sub>8</sub>	15 <sup>3</sup> / <sub>4</sub> / 14 <sup>3</sup> / <sub>8</sub>	17 <sup>3</sup> / <sub>4</sub> / 21 <sup>7</sup> / <sub>8</sub>	311174	1400	○	7" or 8"	11 <sup>3</sup> / <sub>4</sub>	●	see dealer
TLU2000/91	13	1	4629	36 <sup>5</sup> / <sub>8</sub> / 29 <sup>1</sup> / <sub>2</sub> / 65	14 <sup>5</sup> / <sub>8</sub> / 12	15 <sup>3</sup> / <sub>8</sub> / 18 <sup>1</sup> / <sub>4</sub>	242025	1200	○	7" or 8"	11 <sup>3</sup> / <sub>4</sub>	●	see dealer
TLU2000/92	13	1	4321	36 <sup>5</sup> / <sub>8</sub> / 27 <sup>1</sup> / <sub>8</sub> / 65	14 <sup>5</sup> / <sub>8</sub> / 12	15 <sup>3</sup> / <sub>8</sub> / 18 <sup>1</sup> / <sub>4</sub>	242025	1200	○	7" or 8"	11 <sup>3</sup> / <sub>4</sub>	●	see dealer
TLU2480	13	1	6481	42 <sup>1</sup> / <sub>2</sub> / 35 <sup>3</sup> / <sub>8</sub> / 66 <sup>1</sup> / <sub>8</sub>	15 <sup>3</sup> / <sub>4</sub> / 14 <sup>3</sup> / <sub>8</sub>	17 <sup>3</sup> / <sub>4</sub> / 21 <sup>7</sup> / <sub>8</sub>	315064	1400	○	7" or 8"	11 <sup>3</sup> / <sub>4</sub>	●	see dealer
LLU1250	12		3020	42 <sup>1</sup> / <sub>2</sub> / 26 / 36	- H 15 <sup>3</sup> / <sub>8</sub> / 17 <sup>1</sup> / <sub>8</sub>	H15 <sup>3</sup> / <sub>8</sub> / 17 <sup>1</sup> / <sub>8</sub> -	120796	900	-	6" or 8" 6"	7 <sup>1</sup> / <sub>8</sub>	●	see dealer
KTLU2050/1	12	1	4057	45 <sup>3</sup> / <sub>4</sub> / 31 <sup>5</sup> / <sub>8</sub> / 65	14 <sup>5</sup> / <sub>8</sub> / 12	16 <sup>1</sup> / <sub>2</sub> / 14 <sup>1</sup> / <sub>4</sub>	212636	1200	○	7" or 8"	11 <sup>3</sup> / <sub>4</sub>	●	see dealer
TLU2137/13	12	1	4255	35 <sup>1</sup> / <sub>2</sub> / 29 <sup>1</sup> / <sub>8</sub> / 66 <sup>1</sup> / <sub>8</sub>	15 <sup>3</sup> / <sub>4</sub> / 14 <sup>1</sup> / <sub>4</sub>	17 <sup>3</sup> / <sub>4</sub> / 13 <sup>1</sup> / <sub>4</sub>	221712	1200	○	7" or 8"	11 <sup>3</sup> / <sub>4</sub>	●	see dealer
<b>LIGHTWEIGHT FIREPLACES</b>							Energy Output						
HETTA	14	-	~2138	~33 <sup>1</sup> / <sub>8</sub> / ~27 <sup>1</sup> / <sub>2</sub> / 60 <sup>5</sup> / <sub>8</sub>	18 <sup>1</sup> / <sub>8</sub> / 14 <sup>5</sup> / <sub>8</sub>	-	12.084 - 38.305 BTU/hr			6"	see dealer	see dealer	see dealer

● = STANDARD ○ = OPTIONAL - = NOT POSSIBLE \* Heating area (square footage) will vary depending on how a home was designed, the climate, elevation and operation of the unit.



**ADDITIONAL INFORMATION ON THE TECHNICAL TABLE AND PLANS:**

**Stone:** The soapstone used in all of our models comes from Tulikivi's quarries in Finland.

**Weight:** Soapstone is a natural stone with variations in its weight. Therefore the weight specifications are approximate values.

**Maximum amount of wood (lbs):** The maximum amount of wood that can be used in a single heating session, as specified in the operating manual. Note: in light-weight fireplaces, the maximum amount of wood is lbs/hour.

**Stored energy (Btu):** The amount of energy stored in a fireplace during a single heating session using the amount of wood specified in the operating manual.

**Room area (Sq.Feet):** The room area which can be heated with the fireplace (guidance value). The area to be heated depends on several factors, e.g. the geographic location of the building, the location of the fireplace in the room as well as the physics of the building (constructions and insulations used, thickness of insulation, window area in the room etc.). For lightweight fireplaces the room size recommended for installation is specified. Since the specified value is a guidance value, the size and location of the fireplace and its suitability for the room should always be discussed with your Tulikivi distributor.

**Electric element:** In the chart, Tulikivi fireplaces and bakeovens marked with  can be fitted with electric elements (2.0 kW / 10 A & 3 kW / 10 or 16A) as an option.

**Firebox technology:** Tulikivi whirlbox.

**Clearances to combustibles:** please consult your dealer.

**Flue recommendation:** Always take into account the flue's minimum effective height. The flue connector area has been marked with  in the fireplace's plans. To check which models can be fitted with a flue connector, see the table. Country-specific, regional and local regulations must be followed. When selecting a flue, you should always consult with your authorized Tulikivi dealer.

**Combustion air vent (pipe diameter 150mm):** It is possible to install a combustion air connection under the fireplace, from where the air can be channeled directly into the fire chamber. The adapter for extra secondary air must be ordered separately.

**Top vent (product code + T):** If a footprint drawing (on fold-out page) shows a red circle, the fireplace can be fitted with an optional top vent feature. The top vent does not increase the base dimensions of group 1 models, if a Tulikivi whirlbox model is fitted with a top vent, its depth is increased by 4 1/8" (marked with ---). In group 2 models' footprint, the depth measurement of top vent models is stated in brackets ( ).

**Note:** Connecting Tulikivi-unit to a masonry or flue tile chimney, use comparable size. All models are UL/ULC listed. For reduced clearances (up to 3"), see TTM 1 or contact your Tulikivi-dealer. Minimum chimney height is 17 feet from firebox floor to the top. Uninsulated outside chimney is recommended to reline and insulate! Weight/overall dimensions/firebox- and bakeoven dimensions are approx. Values, +/- 1%! 1" = 25,4mm / 1 kg = 2,2 lbs. Heating area (square footage) will vary depending on how a home was designed, the

climate, elevation and operation of the unit.

**Technical changes:** The manufacturer reserves the right to make any technical changes or improvements to the products in this catalog after it has gone into print. The accessories in the images, such as hearth tiles, benches, pedestals and shelves, are not included in a standard delivery. Local regulations in certain countries may stipulate changes to the place of installation, accessories and flue connector of the fireplaces in this catalog. A hearth protection made of a non-combustible material must be placed in front of a fireplace. Country-specific, regional and local regulations must be followed when determining clearance to combustibles. Soapstone is a natural material which characteristically exhibits slight variations in color and pattern. The product images displayed in this catalog may not completely match the delivered product.

Dimensions in the footprints on the next pages are given in inches:	
1/4 = 5mm	3 7/8 = 100mm
3/8 = 10 mm	7 7/8 = 200 mm
3/4 = 20 mm	11 3/4 = 300 mm
1 3/8 = 30 mm	15 3/4 = 400 mm
1 5/8 = 40 mm	19 5/8 = 500 mm
2 = 50 mm	23 5/8 = 600 mm
2 3/8 = 60 mm	27 1/2 = 700 mm
2 3/4 = 70 mm	31 1/2 = 800 mm
3 1/8 = 80 mm	35 3/8 = 900 mm
3 1/2 = 90 mm	39 3/8 = 1000 mm

# FIREPLACES

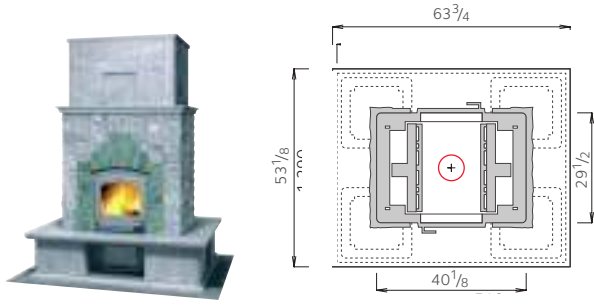

TU2700/2 • Weight 9612 lbs • Height 86 1/2"

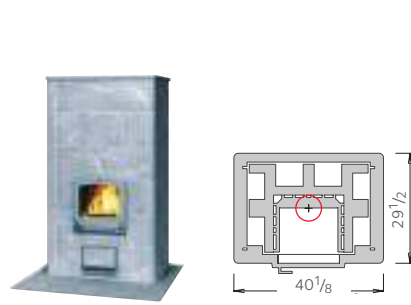

TU2700/4 • Weight 5688 lbs • Height 72"

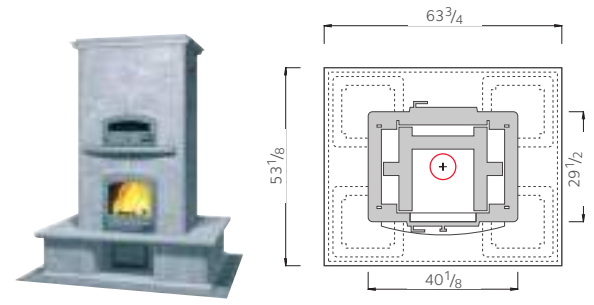

TU2700/51 • Weight 8421 lbs • Height 86 1/2"

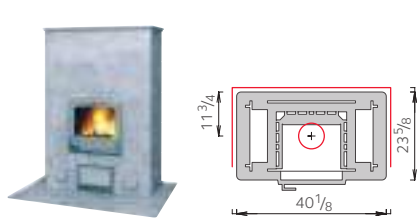

TU2200 • Weight 4056 lbs • Height 60 1/4"

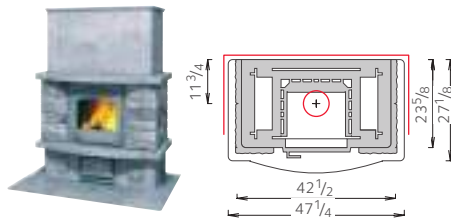

TU2200/1 • Weight 4806 lbs • Height 65"

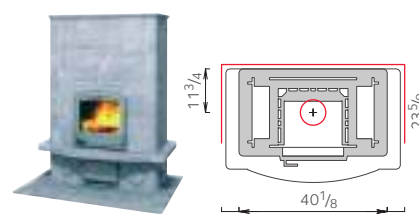

TU2200/4 • Weight 4123 lbs • Height 62 5/8"

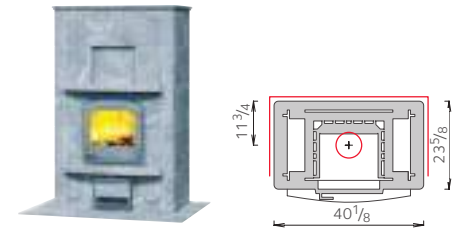

TU2200/5 • Weight 4144 lbs • Height 65"

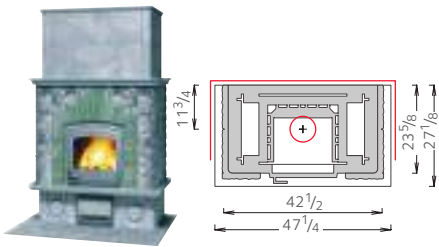

TU2500L • Weight 5247 lbs • Height 76 3/4"

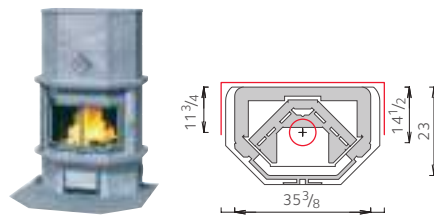

TU1237/51 • Weight 3196 lbs • Height 65"

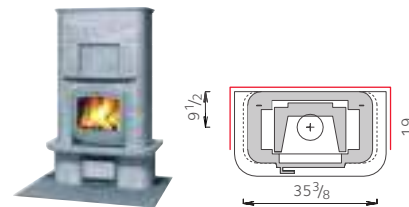

TU1450/1 • Weight 2976 lbs • Height 62 5/8"

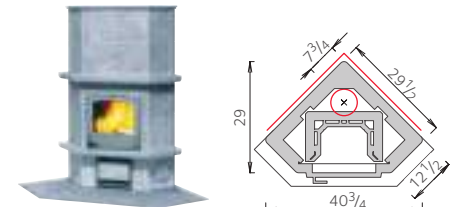

KTU1410/1 • Weight 3042 lbs • Height 65"

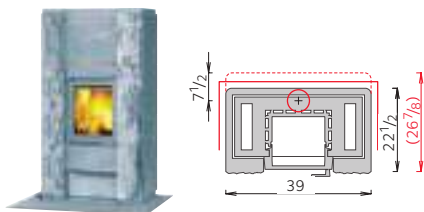

PAHTA/F • Weight 4056 lbs • Height 69 5/8"  
PAHTA/F T • Weight 4673 lbs • Depth 26 7/8"

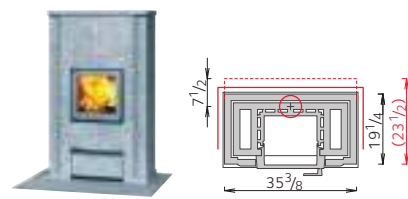

SILO/C • Weight 2755 lbs • Height 60 1/4"  
SILO/C T • Weight 3174 lbs • Depth 23 1/2"

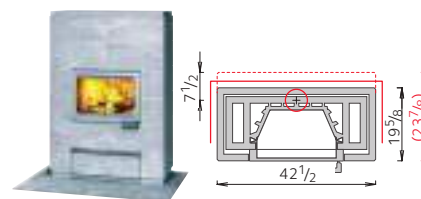

VALKIA • Weight 3350 lbs • Height 60 1/4"  
VALKIA T • Weight 3825 lbs • Depth 23 7/8"

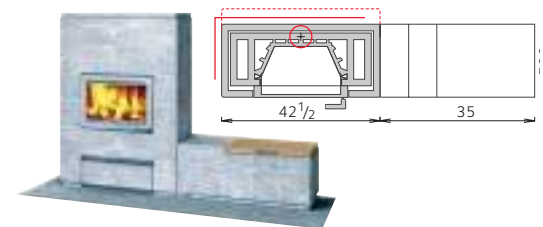

VALKIA + Bench • Weight 3967 lbs • Height 60 1/4"  
VALKIA T + Bench • Weight 4442 lbs • Depth 23 7/8"



## FIREPLACE-BAKEOVENS

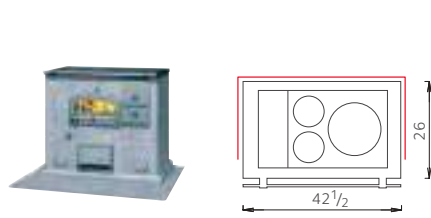

LLU 1250 • Weight 3020 lbs • Height 36"

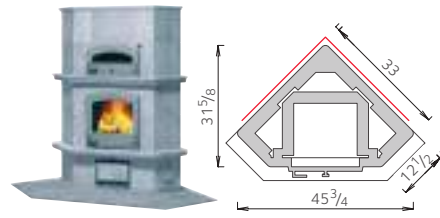

KTLU 2050/1 • Weight 6261 lbs • Height 66 1/8"

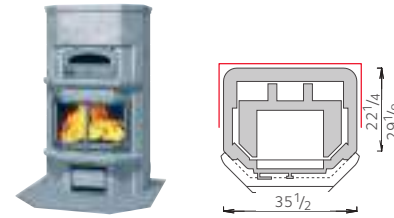

TLU 2137/13 • Weight 4255 lbs • Height 66 1/8"

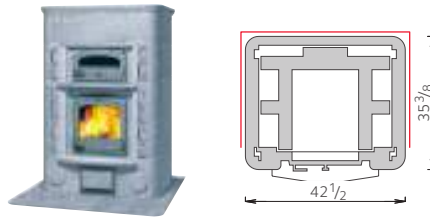

TLU 2450/1 • Weight 6261 lbs • Height 66 1/8"

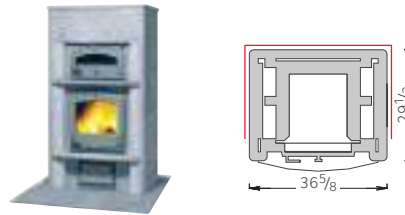

TLU 2000/91 • Weight 4629 lbs • Height 65"

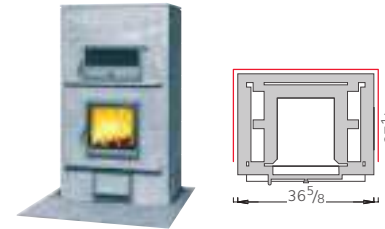

TLU 2000/92 • Weight 4321 lbs • Height 65"

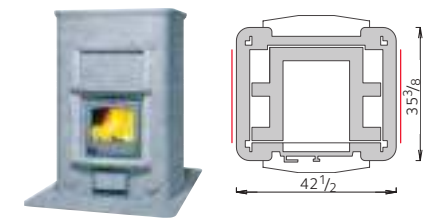

TLU 2480 • Weight 6481 lbs • Height 65"

## LIGHTWEIGHT FIREPLACES

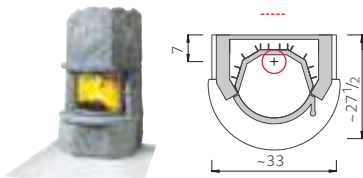

HETTA • Weight ~2138 lbs • Height 60 5/8"

Top vent flues in group 2 models: Please note that T models (top vent) need an extra 4 1/8" in depth. \*) The dimensions of the modular wooden bench PM002 for models Valkia T remain unchanged. The modular feature will be flush mounted with the back of the fireplace. The order codes of top connection models and their dimensions are marked in red. The outer dimensions are the dimensions of the fireplace structure. Please verify the dimensions of the pedestal using the installation instructions, which are included on the pallet.









Your Authorized Tulikivi Dealer:



**OUR REPRESENTATIVES:** **USA & Canada** Tulikivi US Inc., 195 Riverbend Drive - Suite 3, Charlottesville, VA 22911, Tel. (800) 843 3473. **Finland & Scandinavia** Tulikivi Oyj, FI-83900 Juuka, Tel. +358 207 636 000. **Germany** Tulikivi Oyj Niederlassung Deutschland, Bergstraße 11, D-63589 Linsengericht/Eidengesäß, Tel. +49 6051 88 90843. **France** Tulikivi Oyj, 75 avenue Parmentier, F-75011 Paris, Tel. +33 1 40 21 25 65. **Benelux** Dutry & Co., Jagershoek 10, B-8570 Vichte, Belgium, Tel. +32 56 776 090. **Switzerland** Armaka AG, Duggingerstrasse 10, CH-4153 Reinach BL, Tel. +41 61 715 9911. **Austria** Neuhauser-Specks-tein-Öfen, Bahnhofstrasse 54, A-4810 Gmunden, Tel. +43 7612 744 58. **Italy** Eurotrias S.r.l., Via Max Planck 13, I-39100 Bolzano, Tel. +39 0 471 20 16 16. **Slovakia** Talc s.r.o., Jilemnického 390, SK-976 45 Hronec, Tel. +421 904 945 777. **Slovenia** Horizont DOM, d.o.o., Log 50, SI-8294 Boštani, Tel. +386 1 251 66 00, Tel. +386 1 251 66 00. **Estonia** Tulikivi Studio Tallinn, Pihlaka 1a, EE-11216 Tallinn, Tel. +372 655 5486. **Latvia** SIA Akmens Krāsnis, Pulkveža Brieža 43, LV-1045 Rīga, Tel./ Faks + 371 6738 1149. **Lithuania** Kad nebūtų šalta, UAB, Bangų 22a, LT-91250 Klaipėda, Tel. +370 46 256 300. **Poland** TECH PIEC, ul.B.Chrobrego 44A, PL 58-230 Niemcza, Tel. +48 74 8376 032. **Czech Republic** Sumeru Company s.r.o, Finská 1, CZ-10100 Prague 10, Tel. +420 777 718 722. **Ukraine** Finno Log Home, ul. Oleny Teligy 8, 04112 Kiev, Tel. +380 44 4556 456. **Russia** OOO Tulikivi, 1-ya Konnaya Lahta, 1, 197229 St. Petersburg, Tel. +7 911 831 30 22. [www.tulikivi.com](http://www.tulikivi.com)